

Article number: 2310304031ESD

Description: E+G Antistatic base for levelling elements
LV.A-70-14-M10x98-ESD-C

Measures

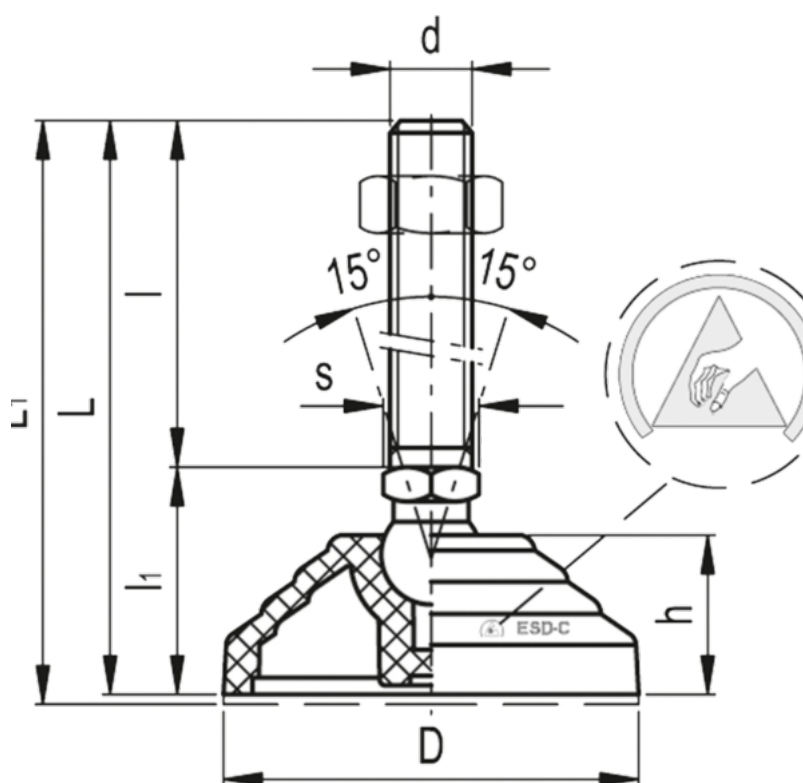

Articulation = 14
D = 70
d = M10
h = 19
l = -
l1 = -
L = 126
Max load = 14000

s = 14
Weight in (g) = 95